

ANWENDUNG

Der Ventilator ist für den Transport von nicht aggressiven und nicht explosiven Gasen ohne Verunreinigungen ausgelegt.

Typische Anwendungen sind:

- Zu-/Abluft in individuellen Lüftungs- und Klimaanlage,
- Kühlung, Trocknungssysteme,
- Werkstattbelüftung.

KONSTRUKTION

- Niederdruck-Radialventilator mit Direktantrieb,
- Laufrad aus geschweißtem Stahlblech mit vorwärts gekrümmten Schaufeln, dynamisch ausgewuchtet nach ISO 1940-1,
- Gehäuse aus einer Aluminiumlegierung gegossen,
- Einlass mit verzinktem Schutzgitter,
- Ventilatorsockel bei den Modellen 160A, 180-225,
- Motorsockel bei Modell 250,
- Ventilator lackiert in grau RAL 7042,
- maximale Ausblastemperatur 80°C,
- Umgebungstemperatur des Motors von -20°C bis +40°C,
- Ausführung LG270.

ELEKTROMOTOR

- asynchron, einphasig, 230V, 50Hz (bis zu 1,5 kW),
- asynchron, dreiphasig, 230/400V, 50Hz (bis zu 3 kW),
- asynchron, dreiphasig, 400/690V, 50Hz (ab 4 kW),
- Schutzart IP55,
- Isolationsklasse F,
- für Frequenzregelung (Drehstrommotoren).

SONDERAUSFÜHRUNGEN

- jede LG/RD-Figur,
- Lackierung in einer anderen Farbe als der Standardfarbe,
- Motor mit einer anderen als der Standard-Versorgungsspannung und -frequenz,
- Motor mit einer anderen IP-Schutzart,
- Motor mit Sensoren oder zusätzlicher Kühlung,
- Abdichtung zwischen Gehäuse und Motor (Simmering),
- Umgebungstemperatur des Motors unter -20°C und über +40°C.



GEHÄUSESTELLUNGEN

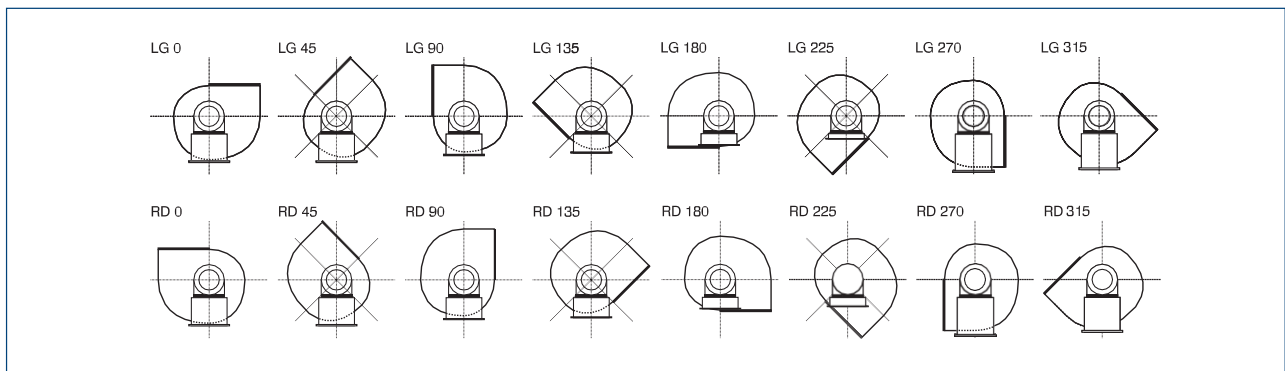

TECHNISCHE DATEN

Typ	Volumenstrom max.	Druck max.	Max. Motorleistung	Drehzahl	Nennstrom	Spannung	Kondensator	Schall-druck-pegel*	Gewicht	ErP	Art.-Nr.
	[m³/h]	[Pa]	[kW]	[1/min]	[A]	[V]	[µF]	[dB(A)]	[kg]		
LFA/2-108/42-005T	205	330	0,05	2900	0,55/0,32	230/400	-	64	3,85	-	45010010
LFA/2-108/42-003S	195	300	0,03	2850	0,9	230	4	64	4	-	45010020
LFA/4-108/42-006T	105	82	0,06	1400	0,43/0,25	230/400	-	61	3,6	-	45010015
LFA/4-108/42-006S	100	75	0,06	1400	0,29	230	4	61	3,6	-	45010023
LFA/2-120/52-012T	510	380	0,12	2800	0,7/0,4	230/400	-	66	5,5	-	45010025
LFA/4-120/52-006T	255	95	0,06	1400	0,43/0,25	230/400	-	46	5,2	-	45010027
LFA/4-120/52-006S	255	95	0,06	1400	0,29	230	4	46	5,2	-	45010028
LFA/2-133/62-018T	690	580	0,18	2760	0,85/0,50	230/400	-	69	6,2	2015	435010030
LFA/2-133/62-018S	680	610	0,18	2840	1,4	230	8	69	6,2	2015	435010040
LFA/4-133/62-006T	340	150	0,06	1400	0,43/0,25	230/400	-	47	5,2	-	45010037
LFA/4-133/62-006S	295	150	0,06	1400	0,29	230	4	47	5,5	-	45010038
LFA/2-146/62-025T	760	670	0,25	2790	1,10/0,65	230/400	-	70	6,5	2015	435010105
LFA/2-146/62-025S	660	680	0,25	2890	1,6	230	8	70	6,5	2015	435010110
LFA/4-146/62-006T	375	175	0,06	1400	0,43/0,25	230/400	-	54	6,4	-	45010106
LFA/4-146/62-006S	320	180	0,06	1400	0,29	230	4	54	6,4	-	45010109
LFA/2-160/75-037T	920	880	0,37	2870	0,95	230/400	-	71	9,2	2015	435010070
LFA/2-160/75-037S	855	848	0,37	2880	2,2	230	25	71	9,4	2015	435010080
LFA/4-160/75-009T	550	195	0,09	1400	0,7/0,4	230/400	-	65	7,1	-	45010076
LFA/4-160/75-009S	550	220	0,09	1420	0,95	230	4	65	7,1	-	45010077
LFA/2-160A/62-055T	1125	920	0,55	2870	2,15 / 1,25	230/400	-	72	12,9	2015	435010141
LFA/2-160A/62-055S	1180	955	0,55	2870	3,1	230	35	72	12,6	2015	435010143
LFA/4-160A/62-018T	715	220	0,18	1400	0,95 / 0,55	230/400	-	57	10,8	2015	435010149
LFA/4-160A/62-018S	680	220	0,18	1400	1,1	230	16	57	11,1	2015	435010150
LFA/2-180/62-055T	1080	975	0,55	2870	2,15/1,25	230/400	-	77	10,85	2015	435010090
LFA/2-180/62-055S	1090	1010	0,55	2870	3,1	230	35/450	77	11	2015	435010100
LFA/4-180/62-012T	530	235	0,12	1340	1,2/0,7	230/400	-	62	10,75	-	435010095
LFA/4-180/62-018S	530	235	0,18	1400	1,1	230	16	62	9,1	-	435010096
LFA/2-180/85-110T	1970	1120	1,1	2890	4,3/2,5	230/400	-	79	19,2	2015	435010102
LFA/2-180/85-110S	1840	1250	1,1	2900	5,8	230	70/450	79	19,5	2015	435010103
LFA/4-180/85-018T	1070	270	0,18	1340	1,2/0,7	230/400	-	71	14,7	2015	435010106
LFA/4-180/85-018S	1070	270	0,18	1400	1,1	230	16	71	14,7	2015	435010107
LFA/2-200/74-150T	2090	1355	1,5	2880	5,25/3,0	230/400	-	78	25,2	2015	435010130
LFA/2-200/74-150S	2160	1345	1,5	2920	8	230	90/450	76	26,5	2015	435010133
LFA/2-215/102-220T	2975	1500	2,2	2885	7,9/4,6	230/400	-	79	29	2015	435010115
LFA/2-225/104-300T	3535	1875	3	2870	11,0/6,3	230/400	-	80	35,4	2015	435010060
LFA/2-250/114-550T	5125	2400	5,5	2890	9,8/5,7	400/690	-	87	37	2015	435010120

* Messung in einem Abstand von 1,5 m vom Ventilator, für Q=2/3*Qmax

LEISTUNGSMERKMALE

- p_t – Gesamtdruck
- p_s – Statischer Druck
- p_d – Dynamischer Druck

MC	Kategorie der Messung
EC	Effizienz Kategorie
VSD	Drehzahlregelung: im Lieferumfang des Ventilators enthalten
SR	Spezifisches Verhältnis
η [%]	Effizienz
N	Wirkungsgrad
[kW]	Max. Motorleistung
[m³/h]	Volumenstrom
[Pa]	Druck
[RPM]	Drehzahl

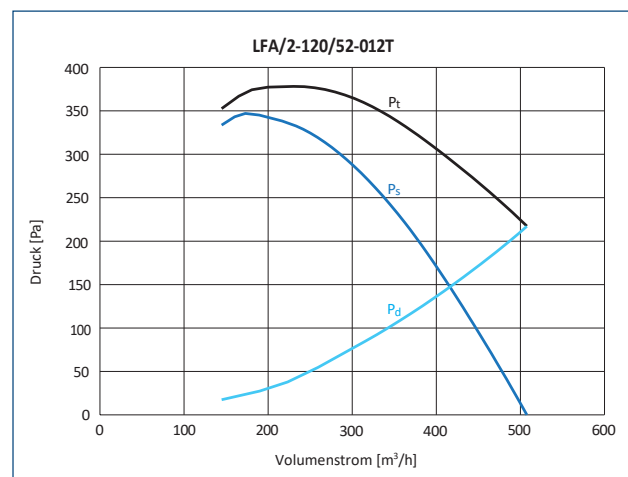
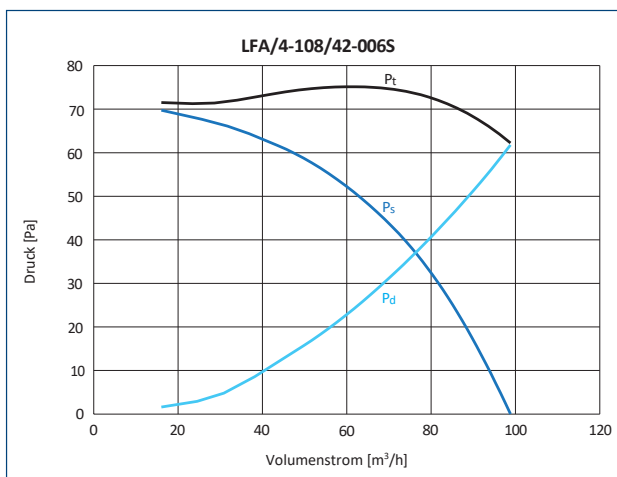
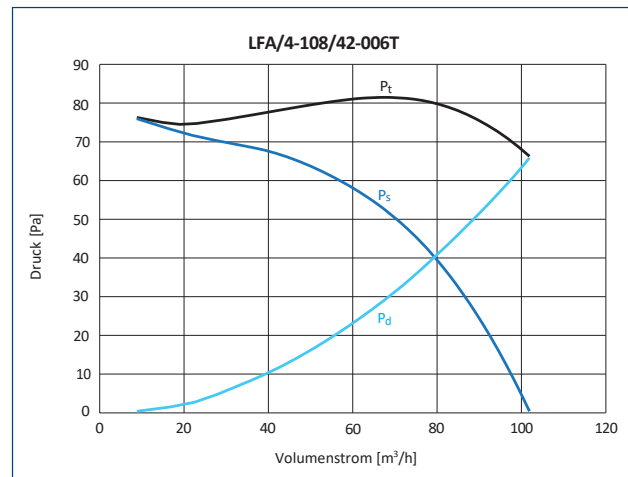
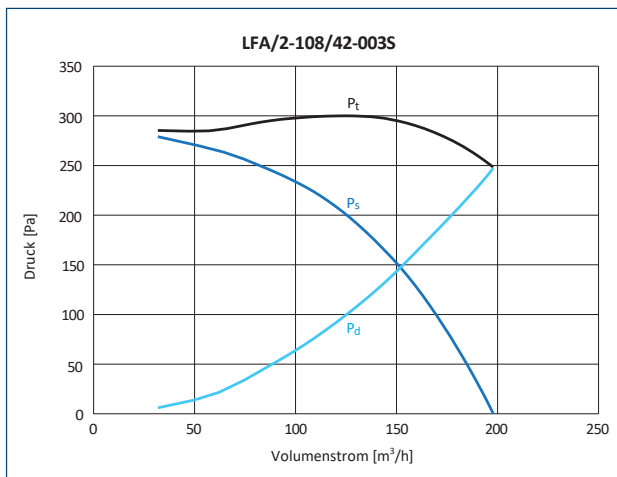
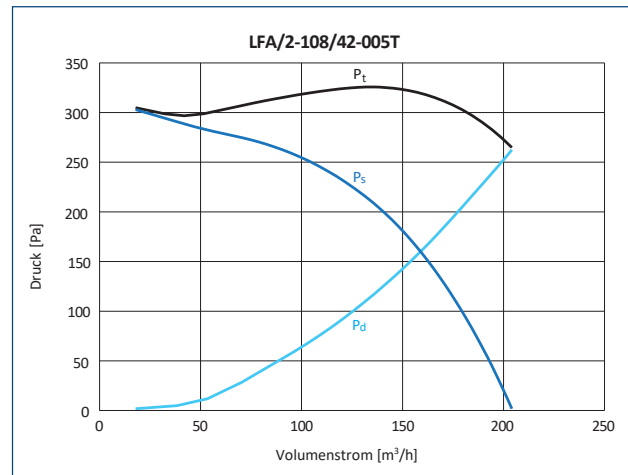

LEISTUNGSMERKMALE

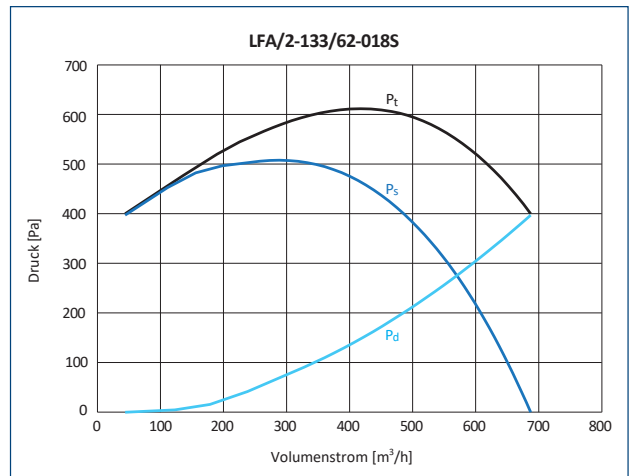
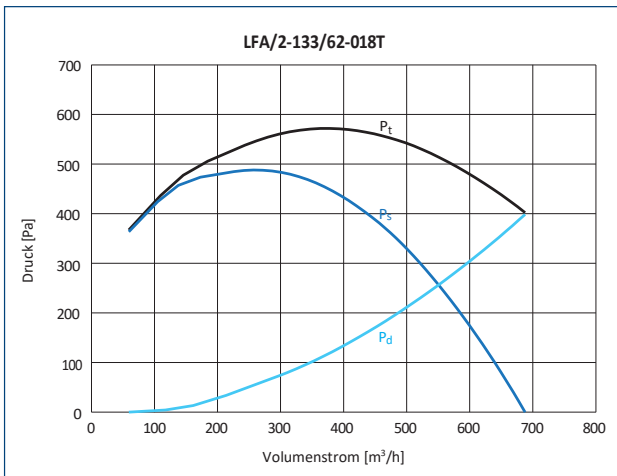
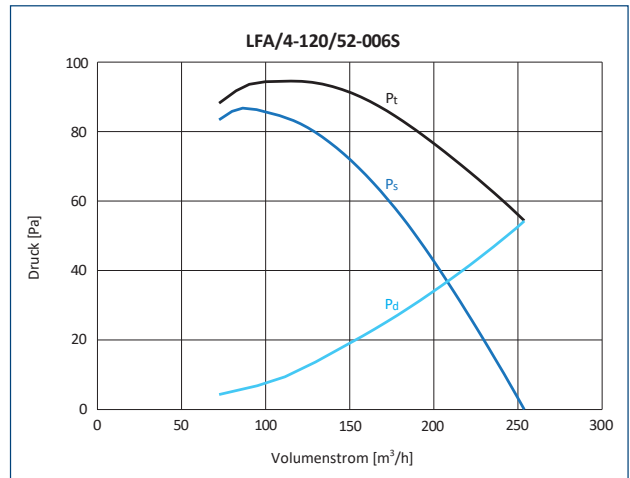
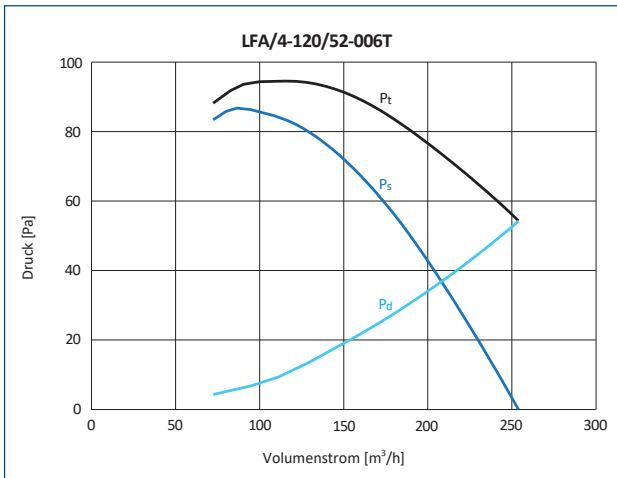

MC	EC	VSD	SR	η [%]	N	[kW]	[m³/h]	[Pa]	[RPM]
B	Gesamt	-	1	41,4	52,8	0,16	406	578	2889

MC	EC	VSD	SR	η [%]	N	[kW]	[m³/h]	[Pa]	[RPM]
B	Gesamt	-	1	39,2	49,8	0,21	484	606	2915

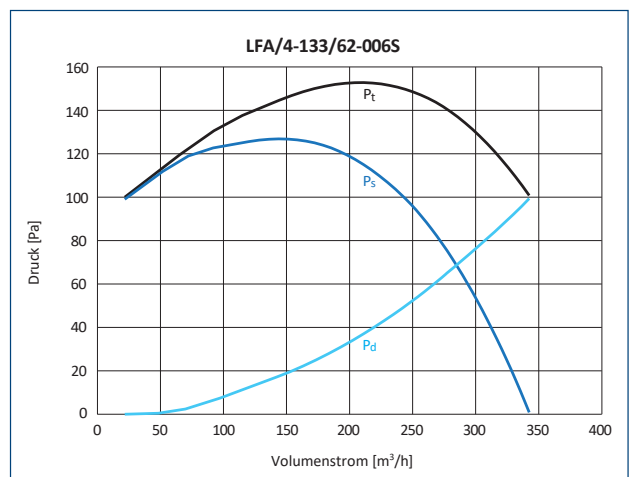
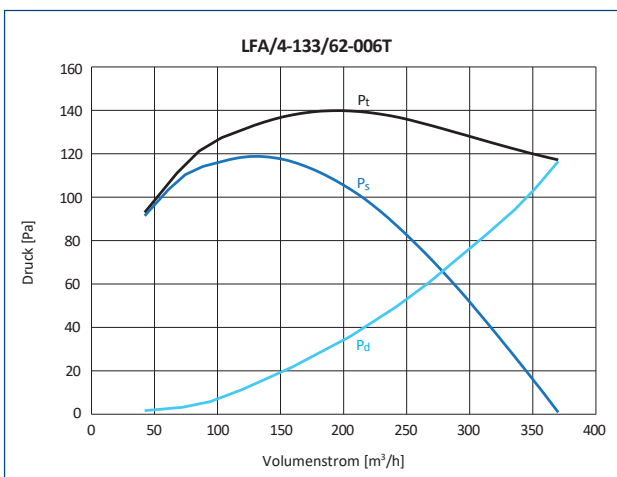

LEISTUNGSMERKMALE

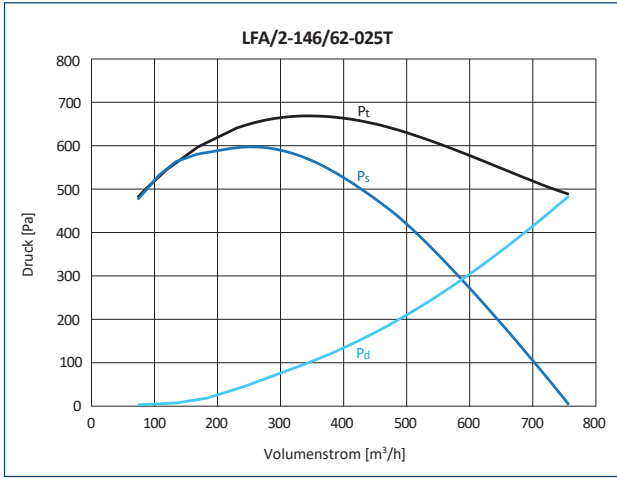

MC	EC	VSD	SR	η [%]	N	[kW]	[m³/h]	[Pa]	[RPM]
B	Gesamt	-	1	41,9	52,9	0,185	410	687	2918

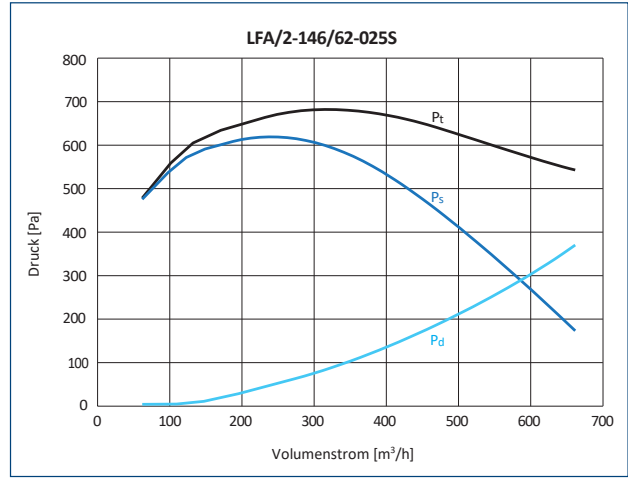

MC	EC	VSD	SR	η [%]	N	[kW]	[m³/h]	[Pa]	[RPM]
B	Gesamt	-	1	39,7	50,2	0,2	446	713	2890

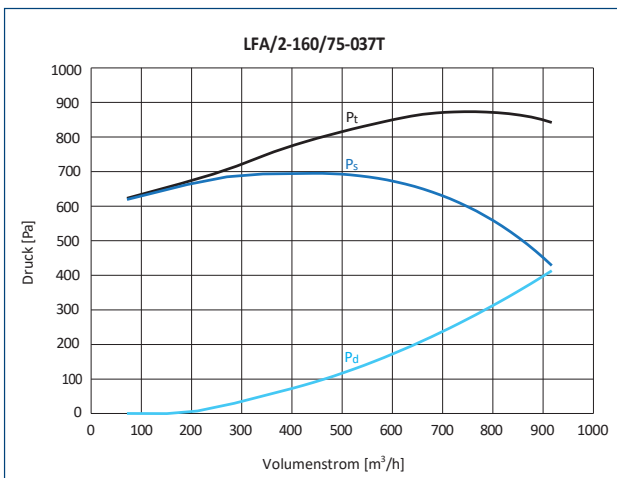
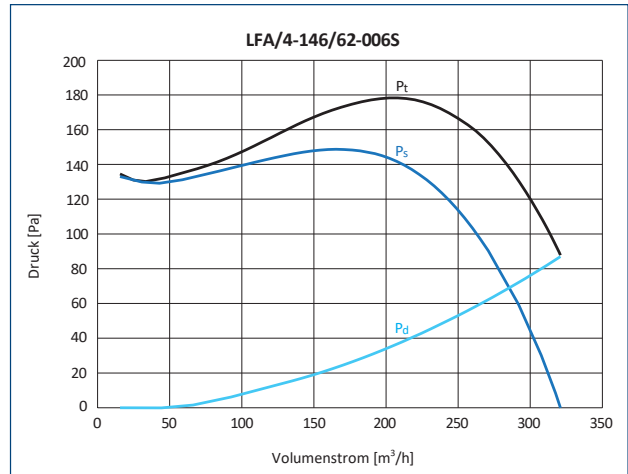
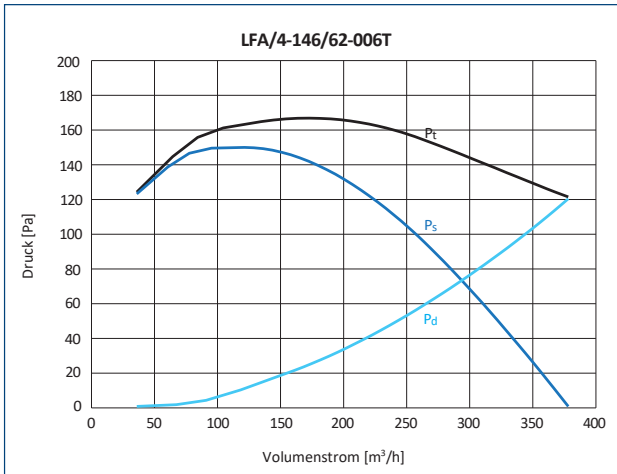

MC	EC	VSD	SR	η [%]	N	[kW]	[m³/h]	[Pa]	[RPM]
B	Gesamt	-	1	44,1	53,1	0,4	680	870	2900

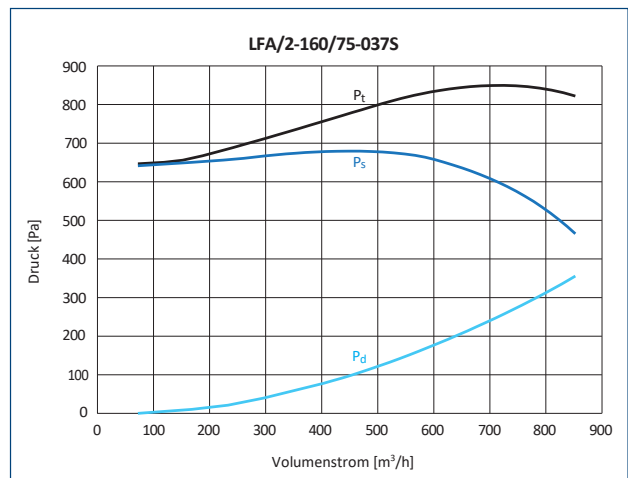

MC	EC	VSD	SR	η [%]	N	[kW]	[m³/h]	[Pa]	[RPM]
B	Gesamt	-	1	41,1	50,0	0,4	692	848	2880

LEISTUNGSMERKMALE

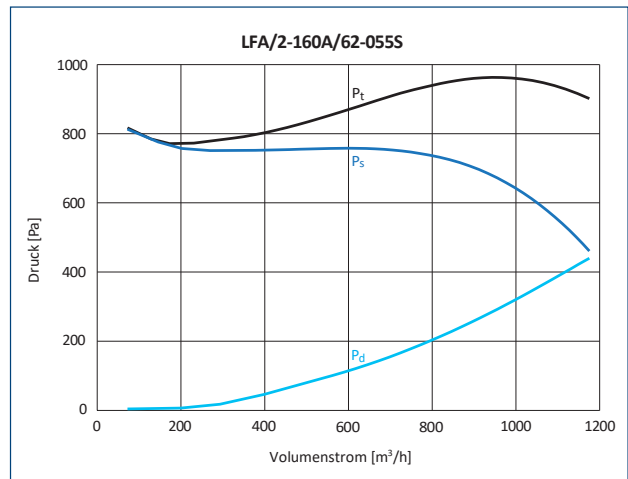
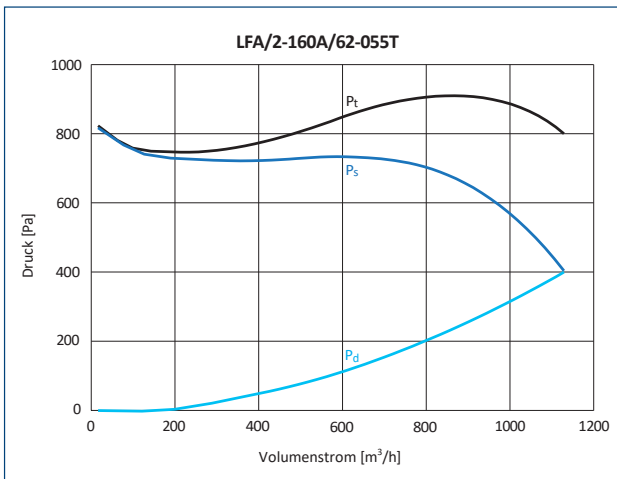
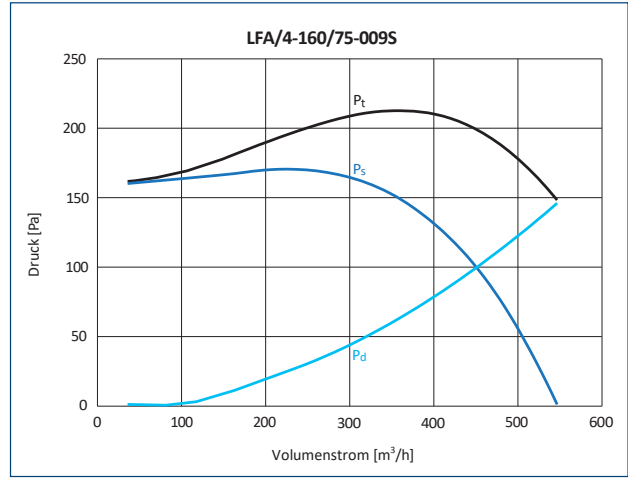
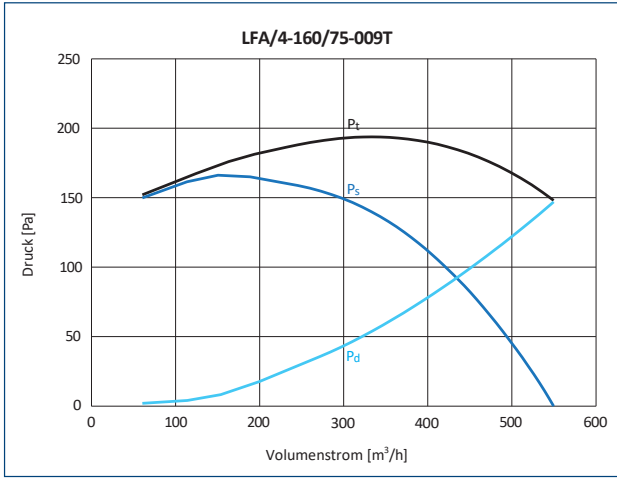

MC	EC	VSD	SR	η[%]	N	[kW]	[m³/h]	[Pa]	[RPM]
B	Gesamt	-	1	50,1	59,2	0,4	761	883	2939

MC	EC	VSD	SR	η[%]	N	[kW]	[m³/h]	[Pa]	[RPM]
B	Gesamt	-	1	44,4	52,3	0,6	946	953	2918

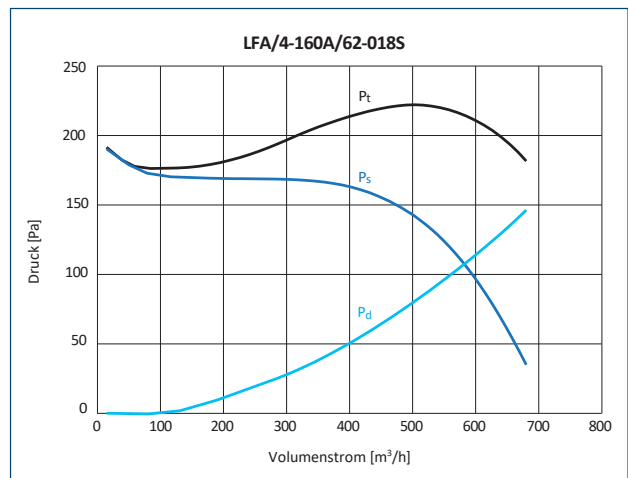
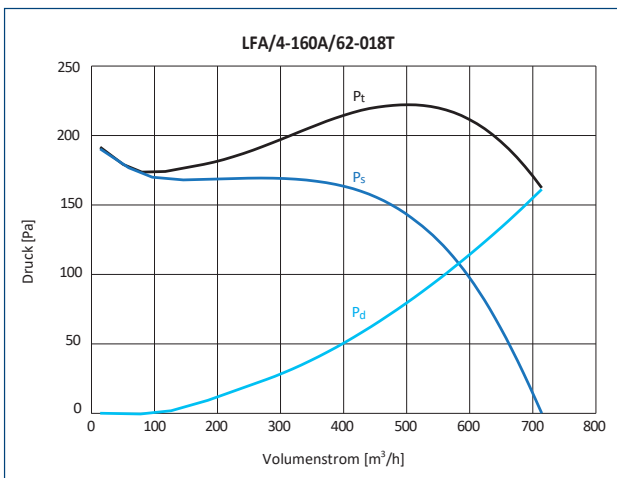

LEISTUNGSMERKMALE

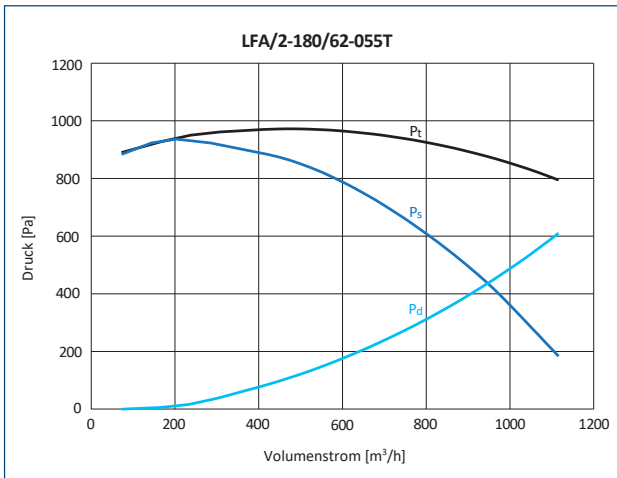

MC	EC	VSD	SR	η [%]	N	[kW]	[m³/h]	[Pa]	[RPM]
B	Gesamt	-	1	45,5	54,6	0,4	575	1019	2949

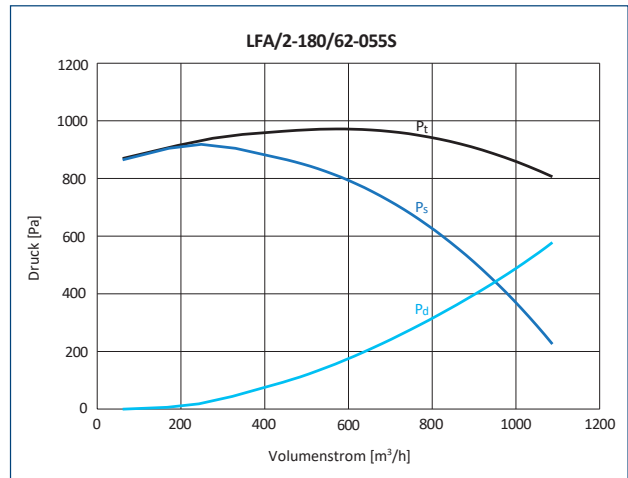

MC	EC	VSD	SR	η [%]	N	[kW]	[m³/h]	[Pa]	[RPM]
B	Gesamt	-	1	40,6	49,4	0,4	581	1007	2950

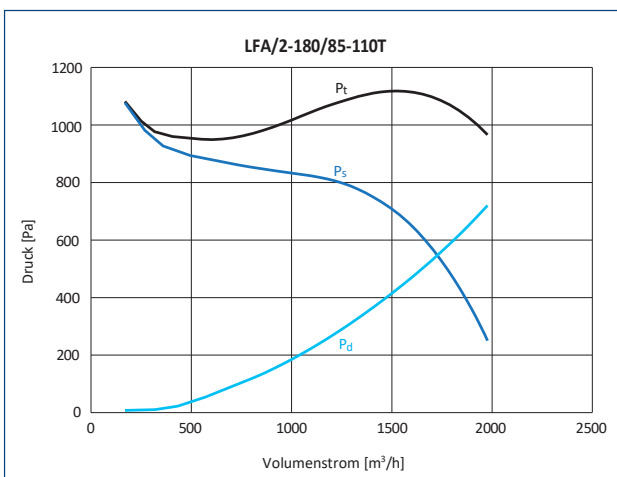
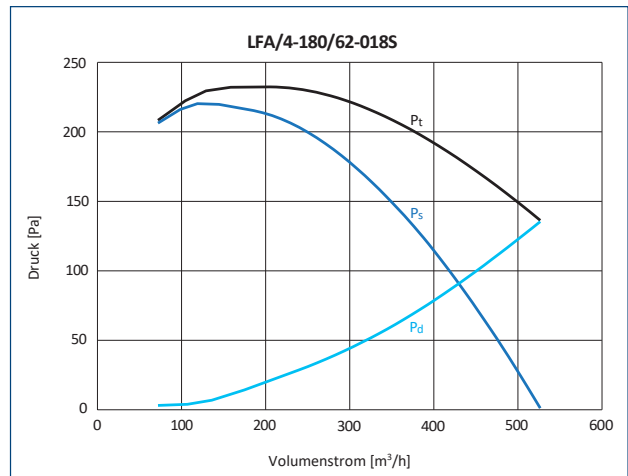
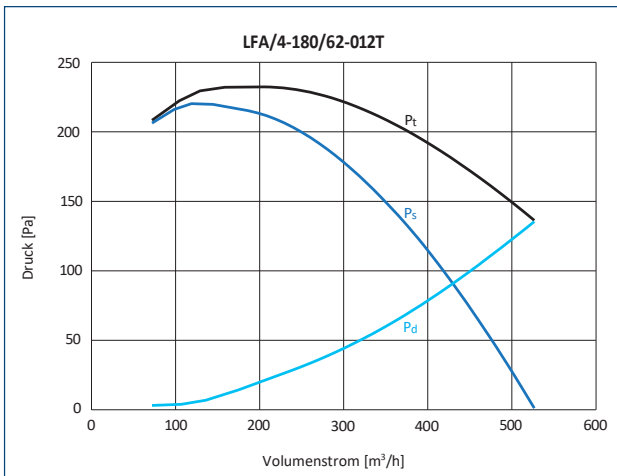

MC	EC	VSD	SR	η [%]	N	[kW]	[m³/h]	[Pa]	[RPM]
B	Gesamt	-	1	48,7	55,3	0,9	1441	1117	2946

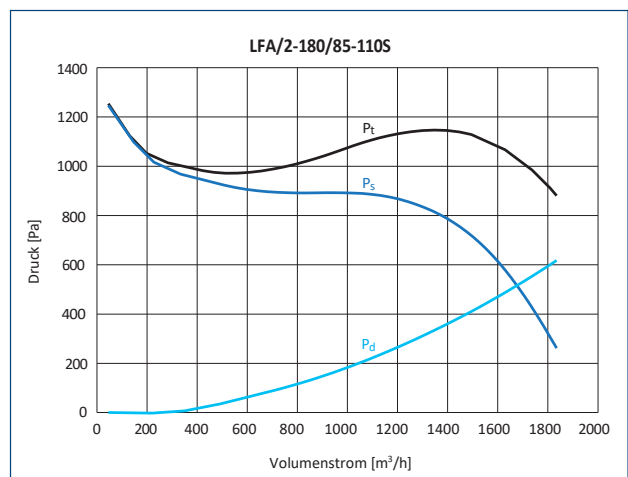

MC	EC	VSD	SR	η [%]	N	[kW]	[m³/h]	[Pa]	[RPM]
B	Gesamt	-	1	45,2	51,7	0,9	1330	1145	2984

LEISTUNGSMERKMALE

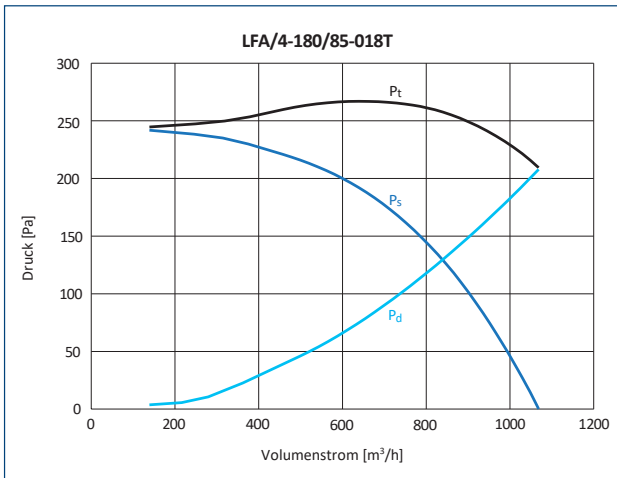

MC	EC	VSD	SR	η [%]	N	[kW]	[m³/h]	[Pa]	[RPM]
B	Gesamt	-	1	39,0	49,7	0,1	743	264	1400

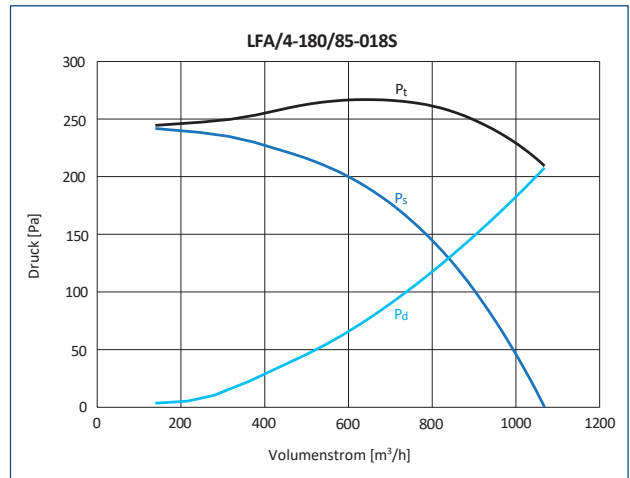

MC	EC	VSD	SR	η [%]	N	[kW]	[m³/h]	[Pa]	[RPM]
B	Gesamt	-	1	39,0	49,7	0,1	743	264	1400

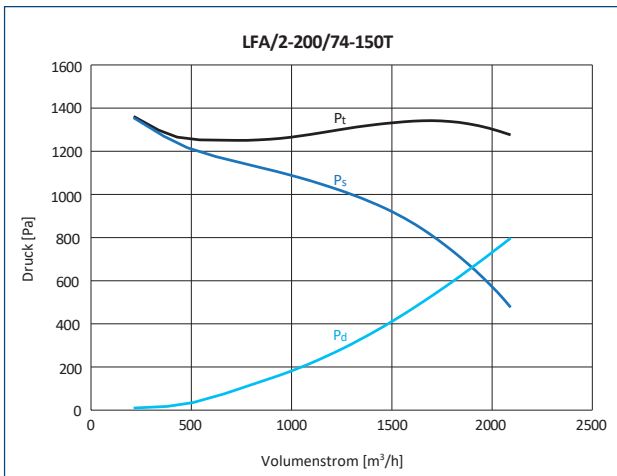

MC	EC	VSD	SR	η [%]	N	[kW]	[m³/h]	[Pa]	[RPM]
B	Gesamt	-	1	45,4	51,3	1,2	1452	1327	2880

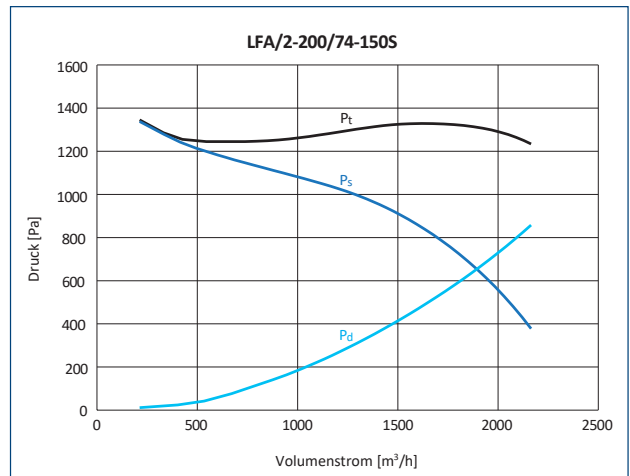

MC	EC	VSD	SR	η [%]	N	[kW]	[m³/h]	[Pa]	[RPM]
B	Gesamt	-	1	46,2	52,0	1,3	1602	1324	2943

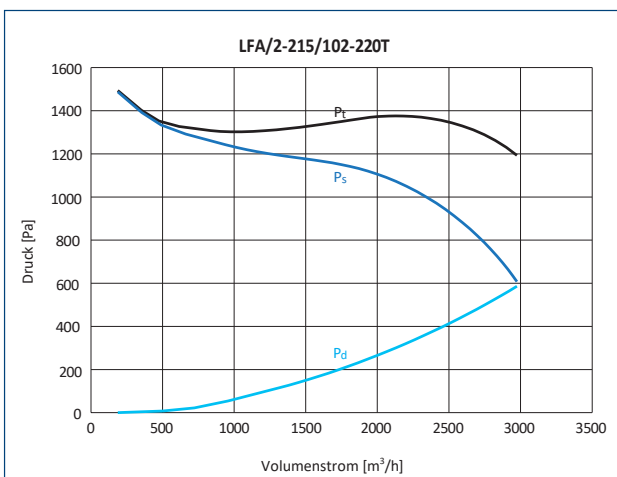

MC	EC	VSD	SR	η [%]	N	[kW]	[m³/h]	[Pa]	[RPM]
B	Gesamt	-	1	44,4	49,3	1,7	1900	1402	2944

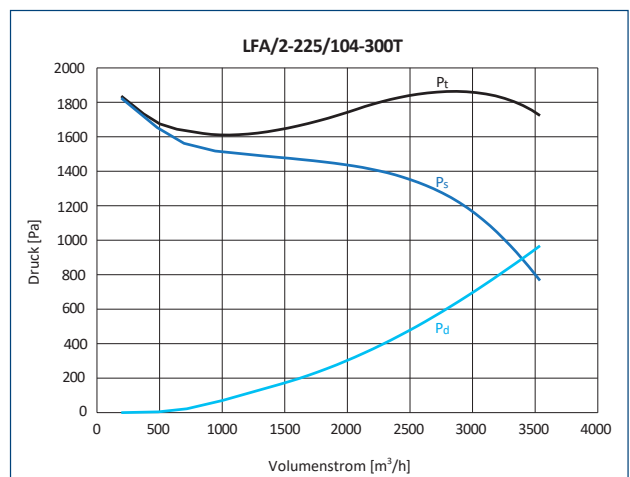

MC	EC	VSD	SR	η [%]	N	[kW]	[m³/h]	[Pa]	[RPM]
B	Gesamt	-	1	54,6	58,3	2,6	2854	1838	2921

LEISTUNGSMERKMALE

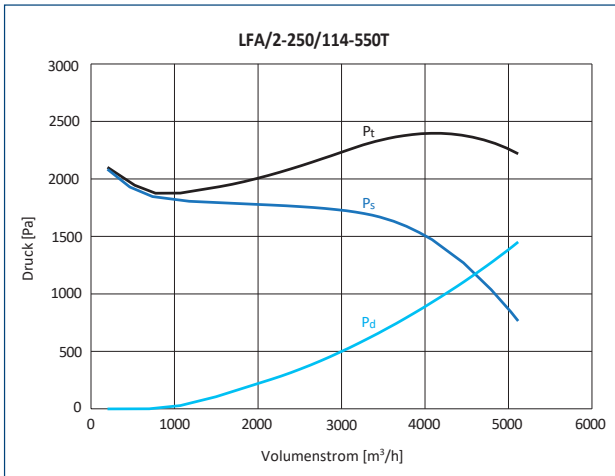

MC	EC	VSD	SR	η[%]	N	[kW]	[m³/h]	[Pa]	[RPM]
B	Gesamt	-	1	60,0	62,6	3,8	3579	2332	3184

ABMESSUNGEN [mm]

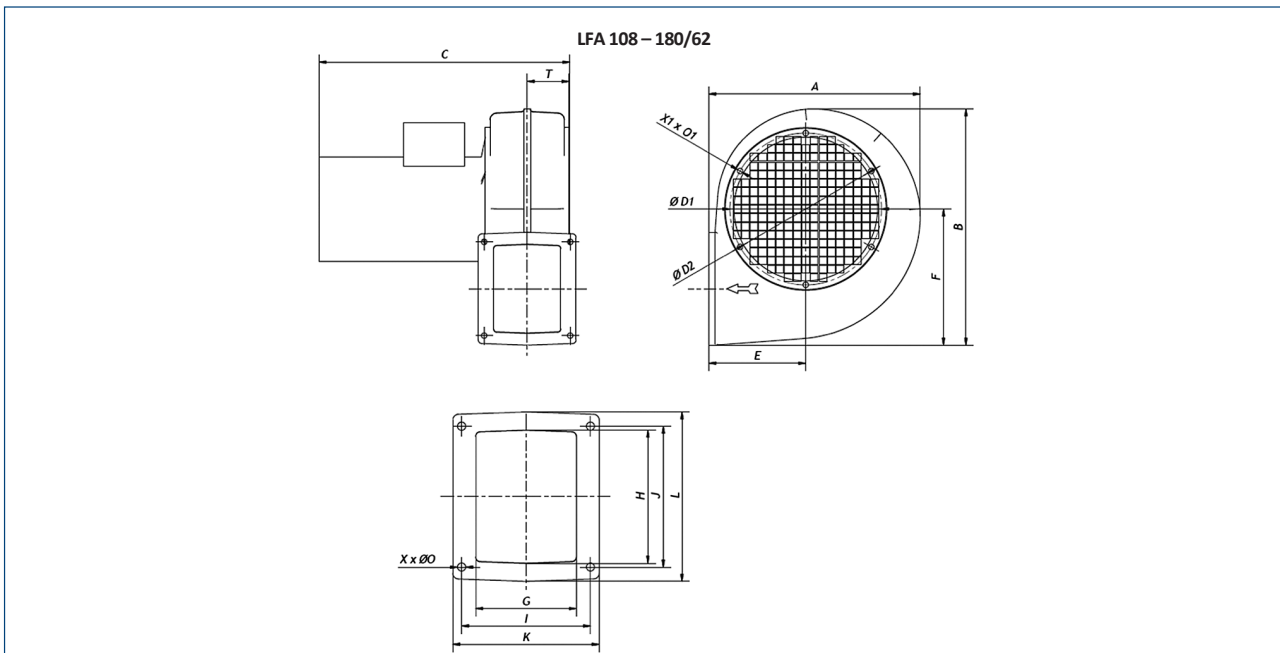

Typ	A	B**	C*	ØD1	ØD2	E	F	G	H	I	J	K	L	T	X	Ø0	X1	Ø01
LFA/2-108/42-005	183	182(**201)	241	120	110	94	103	52	52	56	56	72	72	43	4	7	4	M5
LFA/4-108/42-006	183	182(**201)	254	120	110	94	103	52	52	56	56	72	72	43	4	7	4	M5
LFA/2-120/52-012T	254	254	283	157	135	130	135	86	86	96	96	112	114	55	4	7	4	M5
LFA/4-120/52-006	254	254	283	157	135	130	135	86	86	96	96	112	114	55	4	7	4	M5
LFA/2-133/62-018	254	251(**253)	297	157	135	130	142	86	86	96	96	112	114	55	4	7	4	M5
LFA/4-133/62-006	254	251	283	157	135	130	142	86	86	96	96	112	114	55	4	7	4	M5
LFA/2-146/62-025	254	254	296	157	141	130	142	86	86	96	96	112	114	55	4	7	4	M5
LFA/4-146/62-006	254	254	283	157	141	130	142	86	86	96	96	112	114	55	4	7	4	M5
LFA/2-160/75-037	271	302	300	194	184	124	174	86	113	110	120	125	144	54,5	4	7	4	M6
LFA/4-160/75-009	271	302	300	194	184	124	174	86	113	110	120	125	144	54,5	4	7	4	M6
LFA/2-180/62-055T	271	302	321	194	184	124	174	86	113	110	120	125	144	54,5	4	7	6	M6
LFA/2-180/62-055S	271	302	338	194	184	124	174	86	113	110	120	125	144	54,5	4	7	6	M6
LFA/4-180/62-012	271	302	296	194	184	124	174	86	113	110	120	125	144	55	4	7	6	M6

* Maß C kann je nach Motor variieren.

** Höhe mit Motorgehäuse

ABMESSUNGEN [mm]

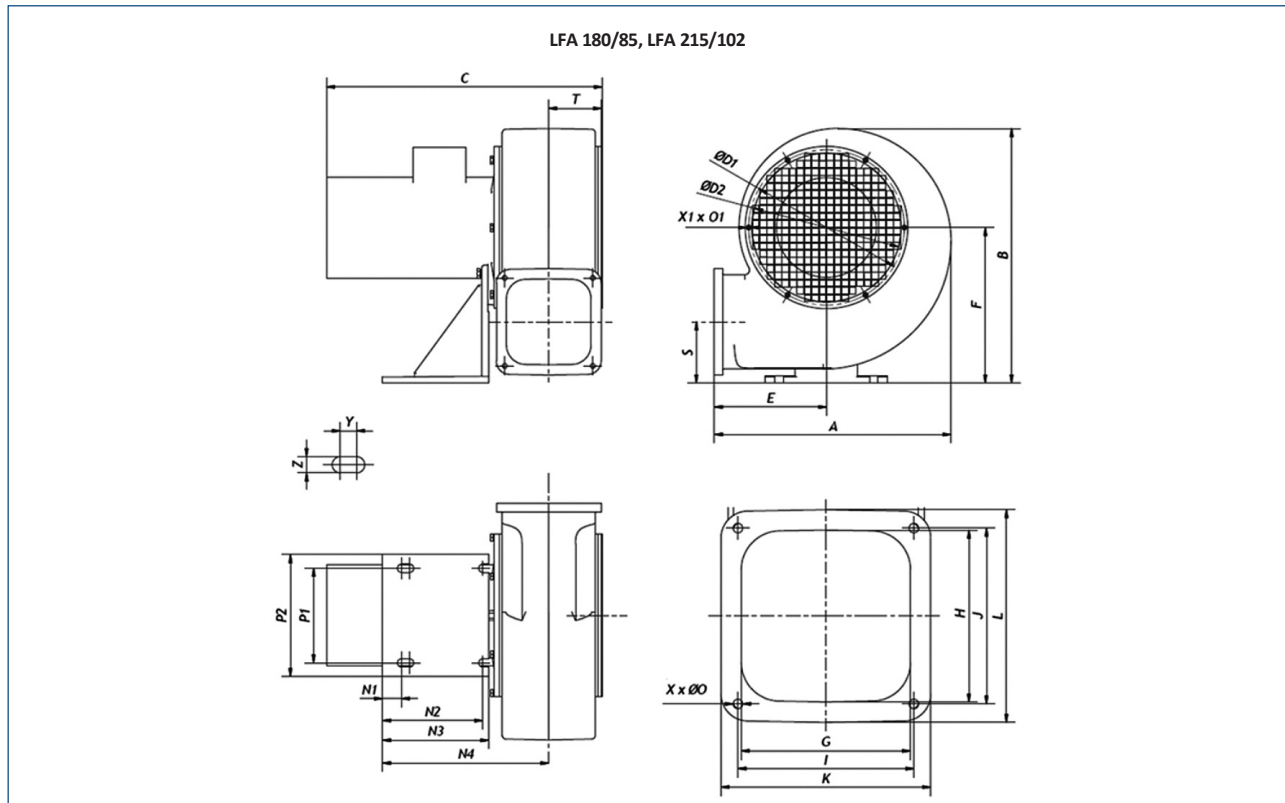

Typ	A	B	C*	ØD1	ØD2	E	F	G	H	I	J	K	L	N1	N2	N3	N4	P1	P2	S	T	X	Ø0	X1	Ø01	Y	Z
LFA/2-180/85-110	349	377	407	230	220	165	230	125	127	130	130	155	157	28	148	157	245	140	180	90	78	4	7	6	M6	12	12
LFA/4-180/85-018	349	377	350	230	210	165	230	125	127	130	130	155	157	28	148	157	237	140	180	90	78	4	7	6	M6	12	12
LFA/2-200/74-150	349	377	471	230	218	165	230	125	127	130	130	155	157	28	148	190	241	140	180	90	78	4	7	6	M6	12	12

* Maß C kann je nach Motor variieren.

ABMESSUNGEN [mm]

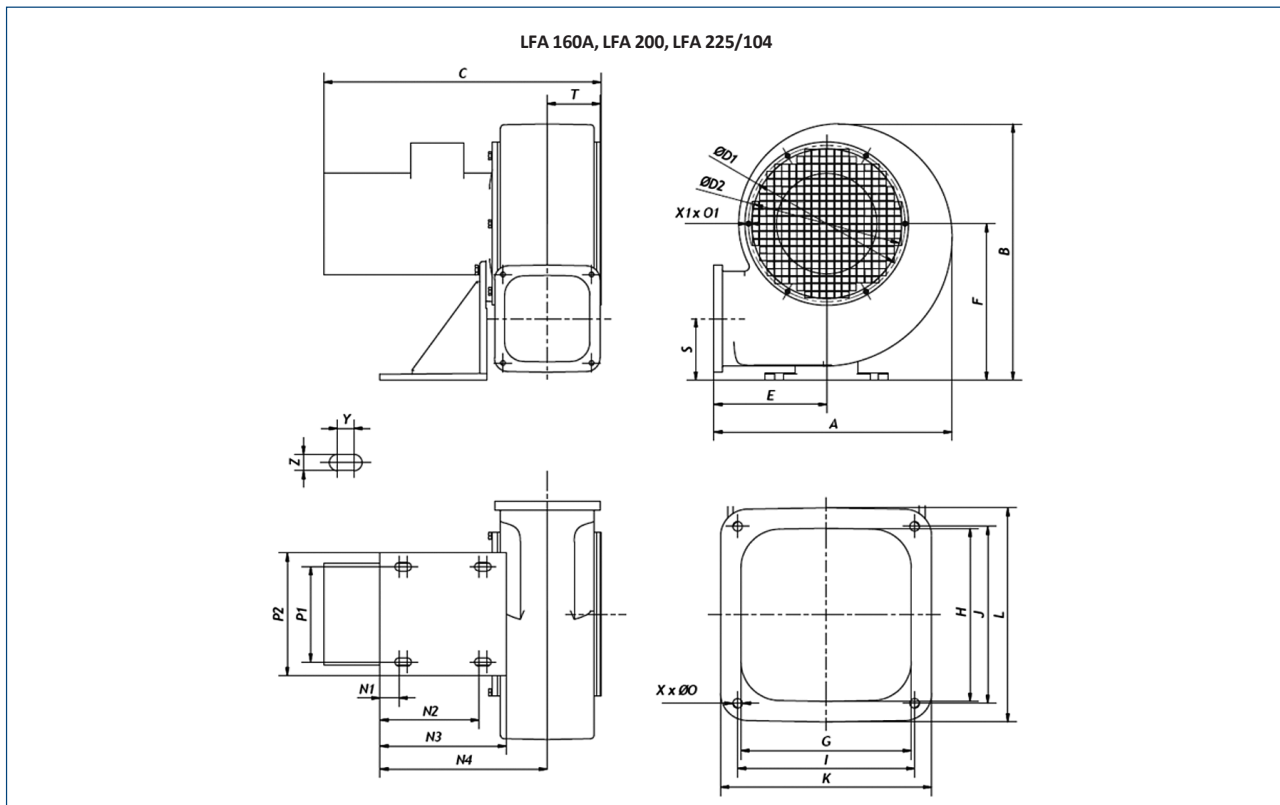

Typ	A	B	C*	ØD1	ØD2	E	F	G	H	I	J	K	L	N1	N2	N3	N4	P1	P2	S	T	X	Ø0	X1	Ø01	Y	Z
LFA/2-160A/62-055T	286	312	304	176	160	140	185	110	110	115	115	140	147	20	120	150	235	95	125	78	69	4	9	4	M5	11	10
LFA/2-160A/62-055S	286	312	304	176	160	140	185	110	110	115	115	140	147	20	120	150	235	95	125	78	69	4	9	4	M5	11	10
LFA/4-160A/62-018T	286	312	286	176	160	140	185	110	110	115	115	140	147	20	120	150	235	95	125	78	69	4	9	4	M5	11	10
LFA/4-160A/62-018S	286	312	286	176	160	140	185	110	110	115	115	140	147	20	120	150	235	95	125	78	69	4	9	4	M5	11	10
LFA/2-225/104-300T	399	450	488	256	235	170	265	155	158	166	166	190	190	29	149	190	297	140	180	100	89	4	12	8	M6	13	12

* Maß C kann je nach Motor variieren.

ABMESSUNGEN [mm]

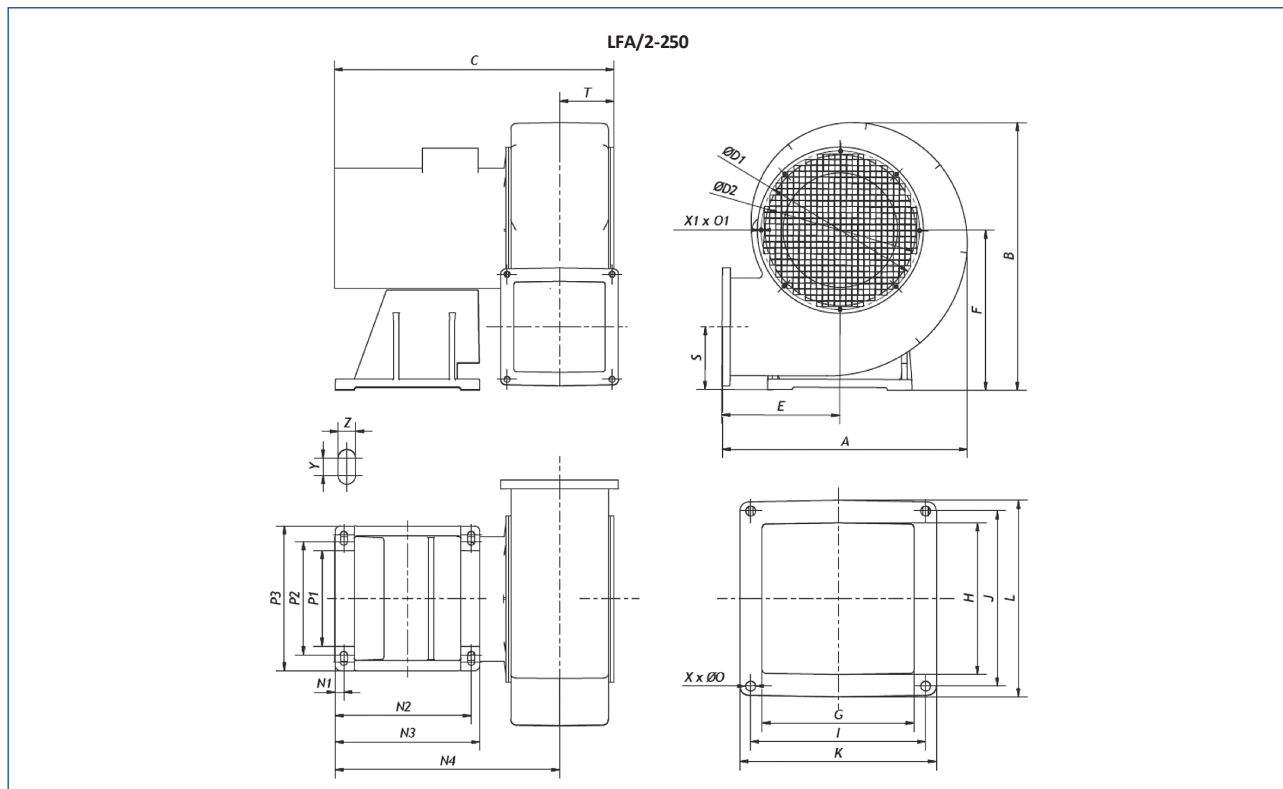

Typ	A	B	C*	ØD1	ØD2	E	F	G	H	I	J	K	L	N1	N2	N3	N4	P1	P2	P3	S	T	X	Ø0	X1	Ø01	Y	Z
LFA/2-250/114-550T	458	499	534	296	281	220	298	170	170	196	196	220	220	16	254	270	419	178	211	270	117	102	4	11	8	M6	13	13

* Maß C kann je nach Motor variieren.

MONTAGEZUBEHÖR

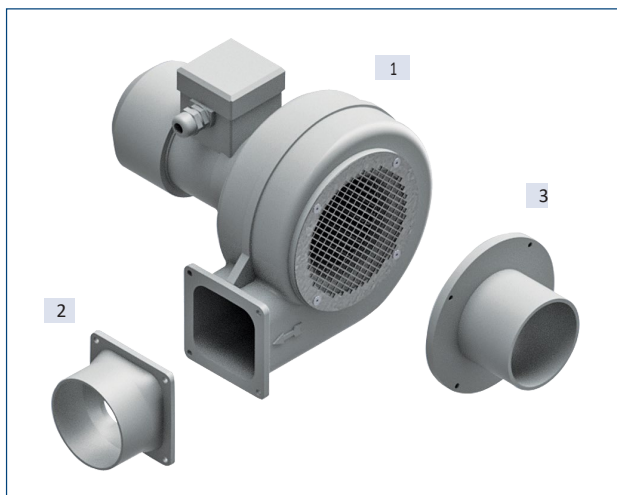

	Auslass	Einlass
	2	3
Ventilator	Ausblasstutzen	Ansaugstutzen
LFA-108/42	-	-
LFA-133/62	24510047-11 (Ø100)	24510047-12 (Ø100)
LFA-146/62	24510047-11 (Ø100)	24510047-12 (Ø100)
LFA-160/75	24510053 (Ø100)	24510049 (Ø150)
LFA-180/62	24510053 (Ø100)	24510094-01 (Ø160)
LFA-180/85	24510054 (Ø125)	24510085-02 (Ø200)
LFA-200/74	24510054 (Ø125)	24510085-02 (Ø200)
LFA-215/102	24510056 (Ø200)	24510085-03 (Ø200)
LFA-225/104	24510057 (Ø160)	25070061-07 (Ø200)
LFA-250/114	24510058 (Ø250)	42517310 (Ø250)













ELEKTRISCHES ZUBEHÖR

Ventilator	Wand-thermostat	Kanal-thermostat	Thyristor-Regler			11-stufiger Thyristor-Regler	ERV	Transformator-Regler		
	TS	TK-1	REB-N	REB-NE	TLR	IRF-900		RMB	RVS	SC2A
LFA/2-108/42-003S	TS	TK-1	-	-	-	-	-	-	-	-
LFA/4-108/42-006S	TS	TK-1	-	-	-	-	-	-	-	-
LFA/4-120/52-006S	TS	TK-1	-	-	-	-	-	-	-	-
LFA/2-133/62-018S	TS	TK-1	REB-2.5 N	REB-2.5 NE	TLR 25 DS	IRF-900	ERV-3	RMB-3.5	RVS-3	SC2A1-25L25
LFA/4-133/62-006S	TS	TK-1	-	-	-	-	-	-	-	-
LFA/2-146/62-025S	TS	TK-1	REB-2.5 N	REB-2.5 NE	TLR 25 DS	IRF-900	ERV-3	RMB-1.5	RVS-1.5	SC2A1-15L25
LFA/4-146/62-006S	TS	TK-1	-	-	-	-	-	-	-	-
LFA/2-160/75-037S	-	TK-1	REB 5		-	IRF-900	ERV-3	RMB-3.5	RVS-3	SC2A1-25L25
LFA/4-160/75-009S	TS	TK-1	-	-	-	-	-	-	-	-
LFA/2-180/62-055S	-	-	REB 5		-	IRF-900	ERV-5	RMB-3.5	RVS-5	SC2A1-35L25
LFA/4-180/62-018S	TS	TK-1	REB-2.5 N	REB-2.5 NE	TLR 25 DS	IRF-900	ERV-3	RMB-3.5	RVS-3	SC2A1-25L25
LFA/2-180/85-110S	-	-	REB 10		-	-	ERV-10	RMB-8	RVS-7	SC2A1-75L25
LFA/4-180/85-018S	TS	TK-1	REB-2.5 N	REB-2.5 NE	TLR 25 DS	IRF-900	ERV-3	RMB-1.5	RVS-1.5	SC2A1-15L25
LFA/2-200/74-150S	-	-	REB 10		-	-	-	RMB-10	RVS-10	SC2A1-110L25

Ventilator	Wechselrichter	Ventilator	Wechselrichter	Ventilator	Wechselrichter
LFA/2-108/42-005T	L 0.4kW	LFA/2-146/62-025T	L 0.4kW	LFA/2-180/85-110T	L 1.5kW
LFA/4-108/42-006T	L 0.4kW	LFA/4-146/62-006T	L 0.4kW	LFA/4-180/85-018T	L 0.4kW
LFA/2-120/52-012T	L 0.4kW	LFA/2-160/75-037T	L 0.4kW	LFA/2-200/74-150T	L 1.5kW
LFA/4-120/52-006T	L 0.4kW	LFA/4-160/75-009T	L 0.4kW	LFA/2-215/102-220T	L 2.2kW
LFA/2-133/62-018T	L 0.4kW	LFA/2-180/62-055T	L 0.75kW	LFA/2-225/104-300T	L 4.0kW
LFA/4-133/62-006T	L 0.4kW	LFA/4-180/62-012T	L 0.4kW	LFA/2-250/114-550T	L 5.5kW

Artikelnummer

ERV-10	40025054	L 1.5kW	40016322	REB-2.5 NE	40025040	RVS-3	40025234	SC2A1-75L25	40025259
ERV-3	40025046	L 2.2kW	40016332	REB-5	40025051	RVS-5	40025235	TK-1	40025330
ERV-5	40025053	L 4.0kW	40016352	RMB-1.5	40025060	RVS-7	40025236	TLR 25 DS	40025045
IRF-900	40015154	L 5.5kW	40016362	RMB-3.5	40025070	SC2A1-15L25	40025251	TS	40025345
L 0.4kW	40016302	REB-10	40025055	RMB-8	40025080	SC2A1-25L25	40025253		
L 0.75kW	40016312	REB-2.5 N	40025030	RVS-1.5	40025232	SC2A1-35L25	40025255		

									
TS Thermostat	TK-1 Thermostat	REB Regler	TLR Regler	IRF Regler	ERV Regler	RMB/RMT Regler	RVS Regler	Transformator 2-stufig	Wechsel- richter